

TL780 SERIES POSITIVE-VOLTAGE REGULATORS

SLVS055F – APRIL 1981 – REVISED DECEMBER 1999

- $\pm 1\%$ Output Tolerance at 25°C
- $\pm 2\%$ Output Tolerance Over Full Operating Range
- Thermal Shutdown
- Internal Short-Circuit Current Limiting
- Pinout Identical to $\mu A7800$ Series
- Improved Version of $\mu A7800$ Series

description

Each fixed-voltage precision regulator in the TL780 series is capable of supplying 1.5 A of load current. A unique temperature-compensation technique, coupled with an internally trimmed band-gap reference, has resulted in improved accuracy when compared to other three-terminal regulators. Advanced layout techniques provide excellent line, load, and thermal regulation. The internal current-limiting and thermal-shutdown features make the devices essentially immune to overload.

The TL780-xxC series regulators are characterized for operation over the virtual junction temperature range of 0°C to 125°C.

**KC PACKAGE
(TOP VIEW)**

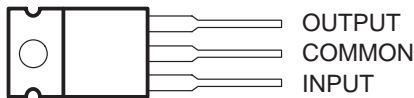

The COMMON terminal is in electrical contact with the mounting base.

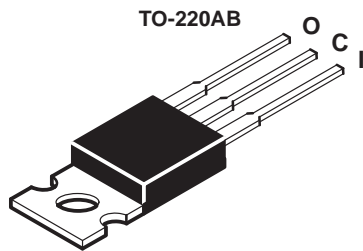

**KTE PACKAGE
(TOP VIEW)**

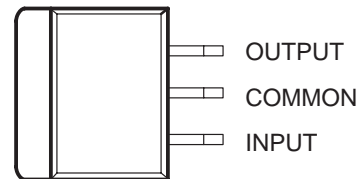

The COMMON terminal is in electrical contact with the mounting base.

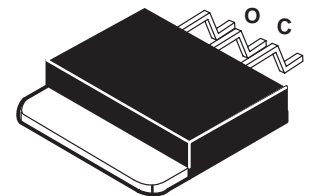

AVAILABLE OPTIONS

T _J	V _O TYP (V)	PACKAGED DEVICES		CHIP FORM (Y)
		HEAT-SINK MOUNTED (KC)	PLASTIC FLANGE MOUNTED (KTE)	
0°C to 125°C	5	TL780-05CKC	TL780-05CKTE	TL780-05Y
	12	TL780-12CKC	TL780-12CKTE	TL780-12Y
	15	TL780-15CKC	TL780-15CKTE	TL780-15Y

The KTE package is available taped and reeled. Add the suffix R to the device type (e.g., TL780-05CKTER). Chip forms are tested at 25°C.



Please be aware that an important notice concerning availability, standard warranty, and use in critical applications of Texas Instruments semiconductor products and disclaimers thereto appears at the end of this data sheet.

PRODUCTION DATA information is current as of publication date. Products conform to specifications per the terms of Texas Instruments standard warranty. Production processing does not necessarily include testing of all parameters.

**TEXAS
INSTRUMENTS**

POST OFFICE BOX 655303 • DALLAS, TEXAS 75265

Copyright © 1999, Texas Instruments Incorporated

TL780 SERIES POSITIVE-VOLTAGE REGULATORS

SLVS055F – APRIL 1981 – REVISED DECEMBER 1999

schematic

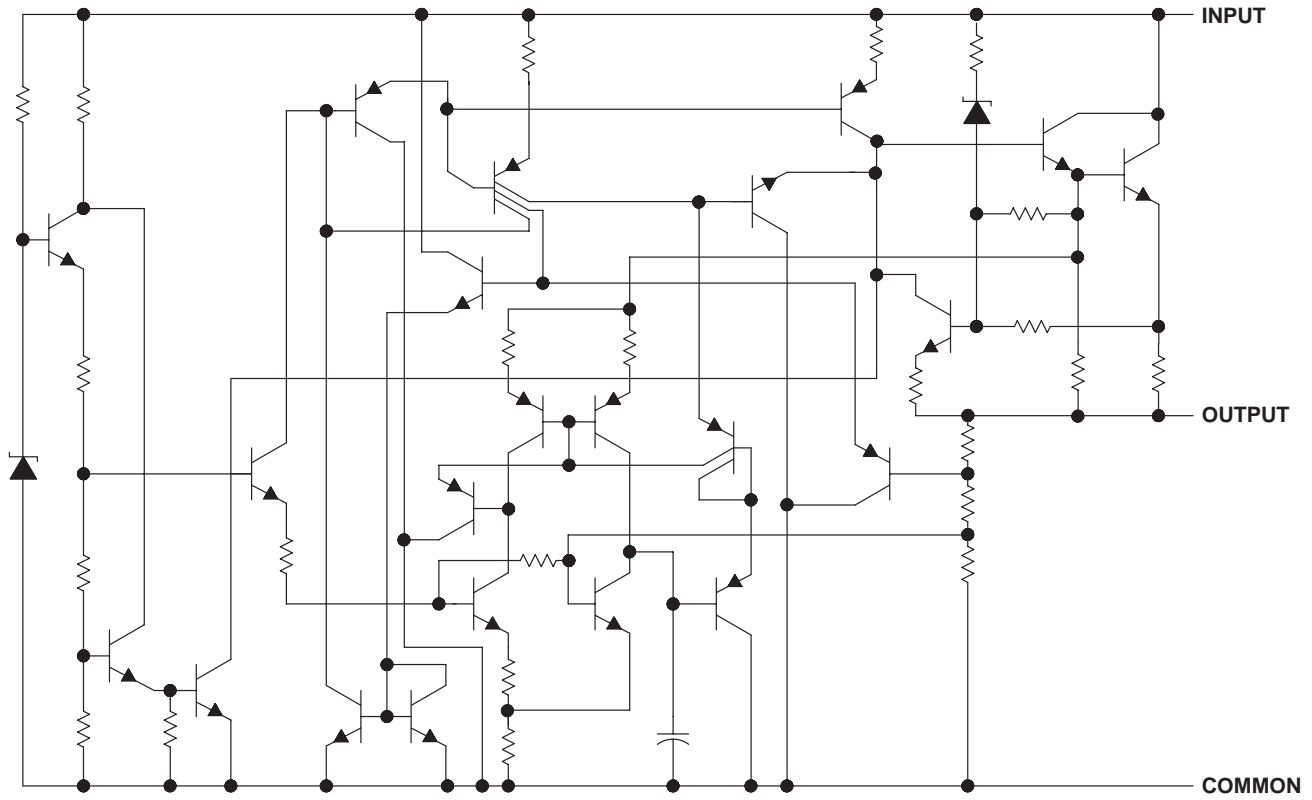

TL780 SERIES POSITIVE-VOLTAGE REGULATORS

SLVS055F – APRIL 1981 – REVISED DECEMBER 1999

absolute maximum ratings over operating temperature range (unless otherwise noted)†

Input voltage, V_I	35 V
Package thermal impedance, θ_{JA} (see Notes 1 and 2): KC package	22°C/W
KTE package	23°C/W
Operating free-air, T_A ; case, T_C ; or virtual junction, T_J , temperature range	0°C to 150°C
Lead temperature 1,6 mm (1/16 inch) from case for 10 seconds	260°C
Storage temperature range, T_{stg}	–65°C to 150°C

† Stresses beyond those listed under “absolute maximum ratings” may cause permanent damage to the device. These are stress ratings only, and functional operation of the device at these or any other conditions beyond those indicated under “recommended operating conditions” is not implied. Exposure to absolute-maximum-rated conditions for extended periods may affect device reliability.

- NOTES: 1. Maximum power dissipation is a function of $T_J(\max)$, θ_{JA} , and T_A . The maximum allowable power dissipation at any allowable ambient temperature is $P_D = (T_J(\max) - T_A)/\theta_{JA}$. Operating at the absolute maximum T_J of 150°C can impact reliability. Due to variations in individual device electrical characteristics and thermal resistance, the built-in thermal overload protection may be activated at power levels slightly above or below the rated dissipation.
2. The package thermal impedance is calculated in accordance with JESD 51.

recommended operating conditions

		MIN	MAX	UNIT
Input voltage, V_I	TL780-05C	7	25	V
	TL780-12C	14.5	30	
	TL780-15C	17.5	30	
Output current, I_O			1.5	A
Operating virtual junction temperature, T_J		0	125	°C

electrical characteristics at specified virtual junction temperature, $V_I = 10$ V, $I_O = 500$ mA (unless otherwise noted)

PARAMETER	TEST CONDITIONS	T_J ‡	TL780-05C			UNIT
			MIN	TYP	MAX	
Output voltage	$I_O = 5$ mA to 1 A, $P \leq 15$ W, $V_I = 7$ V to 20 V	25°C	4.95	5	5.05	V
		0°C to 125°C	4.9		5.1	
Input voltage regulation	$V_I = 7$ V to 25 V	25°C		0.5	5	mV
	$V_I = 8$ V to 12 V			0.5	5	
Ripple rejection	$V_I = 8$ V to 18 V, $f = 120$ Hz	0°C to 125°C	70	85		dB
Output voltage regulation	$I_O = 5$ mA to 1.5 A	25°C		4	25	mV
	$I_O = 250$ mA to 750 mA			1.5	15	
Output resistance	$f = 1$ kHz	0°C to 125°C	0.0035			W
Temperature coefficient of output voltage	$I_O = 5$ mA	0°C to 125°C	0.25			mV/°C
Output noise voltage	$f = 10$ Hz to 100 kHz	25°C	75			μV
Dropout voltage	$I_O = 1$ A	25°C	2			V
Input bias current		25°C	5 8			mA
Input bias-current change	$V_I = 7$ V to 25 V	0°C to 125°C	0.7 1.3		mA	
	$I_O = 5$ mA to 1 A		0.003 0.5			
Short-circuit output current		25°C	750			mA
Peak output current		25°C	2.2			A

‡ Pulse-testing techniques maintain the junction temperature as close to the ambient temperature as possible. Thermal effects must be taken into account separately. All characteristics are measured with a 0.33-μF capacitor across the input and a 0.22-μF capacitor across the output.



TL780 SERIES POSITIVE-VOLTAGE REGULATORS

SLVS055F – APRIL 1981 – REVISED DECEMBER 1999

electrical characteristics at specified virtual junction temperature, $V_I = 19\text{ V}$, $I_O = 500\text{ mA}$ (unless otherwise noted)

PARAMETER	TEST CONDITIONS	T_J †	TL780-12C			UNIT
			MIN	TYP	MAX	
Output voltage	$I_O = 5\text{ mA to }1\text{ A}$, $P \leq 15\text{ W}$, $V_I = 14.5\text{ V to }27\text{ V}$	25°C	11.88	12	12.12	V
		0°C to 125°C	11.76		12.24	
Input voltage regulation	$V_I = 14.5\text{ V to }30\text{ V}$	25°C	1.2		12	mV
	$V_I = 16\text{ V to }22\text{ V}$		1.2		12	
Ripple rejection	$V_I = 15\text{ V to }25\text{ V}$, $f = 120\text{ Hz}$	0°C to 125°C	65	80		dB
Output voltage regulation	$I_O = 5\text{ mA to }1.5\text{ A}$	25°C	6.5		60	mV
	$I_O = 250\text{ mA to }750\text{ mA}$		2.5		36	
Output resistance	$f = 1\text{ kHz}$	0°C to 125°C	0.0035			W
Temperature coefficient of output voltage	$I_O = 5\text{ mA}$	0°C to 125°C	0.6			mV/°C
Output noise voltage	$f = 10\text{ Hz to }100\text{ kHz}$	25°C	180			μV
Dropout voltage	$I_O = 1\text{ A}$	25°C	2			V
Input bias current		25°C	5.5		8	mA
Input bias-current change	$V_I = 14.5\text{ V to }30\text{ V}$	0°C to 125°C	0.4		1.3	mA
	$I_O = 5\text{ mA to }1\text{ A}$		0.03		0.5	
Short-circuit output current		25°C	350			mA
Peak output current		25°C	2.2			A

† Pulse-testing techniques maintain the junction temperature as close to the ambient temperature as possible. Thermal effects must be taken into account separately. All characteristics are measured with a 0.33-μF capacitor across the input and a 0.22-μF capacitor across the output.

electrical characteristics at specified virtual junction temperature, $V_I = 23\text{ V}$, $I_O = 500\text{ mA}$ (unless otherwise noted)

PARAMETER	TEST CONDITIONS	T_J †	TL780-15C			UNIT
			MIN	TYP	MAX	
Output voltage	$I_O = 5\text{ mA to }1\text{ A}$, $P \leq 15\text{ W}$, $V_I = 17.5\text{ V to }30\text{ V}$	25°C	14.85	15	15.15	V
		0°C to 125°C	14.7		15.3	
Input voltage regulation	$V_I = 17.5\text{ V to }30\text{ V}$	25°C	1.5		15	mV
	$V_I = 20\text{ V to }26\text{ V}$		1.5		15	
Ripple rejection	$V_I = 18.5\text{ V to }28.5\text{ V}$, $f = 120\text{ Hz}$	0°C to 125°C	60	75		dB
Output voltage regulation	$I_O = 5\text{ mA to }1.5\text{ A}$	25°C	7		75	mV
	$I_O = 250\text{ mA to }750\text{ mA}$		2.5		45	
Output resistance	$f = 1\text{ kHz}$	0°C to 125°C	0.0035			W
Temperature coefficient of output voltage	$I_O = 5\text{ mA}$	0°C to 125°C	0.62			mV/°C
Output noise voltage	$f = 10\text{ Hz to }100\text{ kHz}$	25°C	225			μV
Dropout voltage	$I_O = 1\text{ A}$	25°C	2			V
Input bias current		25°C	5.5		8	mA
Input bias-current change	$V_I = 17.5\text{ V to }30\text{ V}$	0°C to 125°C	0.4		1.3	mA
	$I_O = 5\text{ mA to }1\text{ A}$		0.02		0.5	
Short-circuit output current		25°C	230			mA
Peak output current		25°C	2.2			A

† Pulse-testing techniques maintain the junction temperature as close to the ambient temperature as possible. Thermal effects must be taken into account separately. All characteristics are measured with a 0.33-μF capacitor across the input and a 0.22-μF capacitor across the output.



TL780 SERIES POSITIVE-VOLTAGE REGULATORS

SLVS055F – APRIL 1981 – REVISED DECEMBER 1999

electrical characteristics, $V_I = 10\text{ V}$, $I_O = 500\text{ mA}$, $T_J = 25^\circ\text{C}$ (unless otherwise noted)

PARAMETER	TEST CONDITION [†]	TL780-05Y			UNIT
		MIN	TYP	MAX	
Output voltage	$I_O = 5\text{ mA to }1\text{ A}, P \leq 15\text{ W}$		5		V
Input voltage regulation	$V_I = 7\text{ V to }25\text{ V}$		0.5		mV
	$V_I = 8\text{ V to }12\text{ V}$		0.5		
Output voltage regulation	$I_O = 5\text{ mA to }1.5\text{ A}$		4		mV
	$I_O = 250\text{ mA to }750\text{ mA}$		1.5		
Output noise voltage	$f = 10\text{ Hz to }100\text{ kHz}$		75		μV
Dropout voltage	$I_O = 1\text{ A}$		2		V
Input bias current			5		mA
Short-circuit output current			750		mA
Peak output current			2.2		A

[†] Pulse-testing techniques maintain the junction temperature as close to the ambient temperature as possible. Thermal effects must be taken into account separately. All characteristics are measured with a 0.33- μF capacitor across the input and a 0.22- μF capacitor across the output.

electrical characteristics, $V_I = 19\text{ V}$, $I_O = 500\text{ mA}$, $T_J = 25^\circ\text{C}$ (unless otherwise noted)

PARAMETER	TEST CONDITION [†]	TL780-12Y			UNIT
		MIN	TYP	MAX	
Output voltage	$I_O = 5\text{ mA to }1\text{ A}, P \leq 15\text{ W}$		12		V
Input voltage regulation	$V_I = 14.5\text{ V to }30\text{ V}$		1.2		mV
	$V_I = 16\text{ V to }22\text{ V}$		1.2		
Output voltage regulation	$I_O = 5\text{ mA to }1.5\text{ A}$		6.5		mV
	$I_O = 250\text{ mA to }750\text{ mA}$		2.5		
Output noise voltage	$f = 10\text{ Hz to }100\text{ kHz}$		180		μV
Dropout voltage	$I_O = 1\text{ A}$		2		V
Input bias current			5.5		mA
Short-circuit output current			350		mA
Peak output current			2.2		A

[†] Pulse-testing techniques maintain the junction temperature as close to the ambient temperature as possible. Thermal effects must be taken into account separately. All characteristics are measured with a 0.33- μF capacitor across the input and a 0.22- μF capacitor across the output.

TL780 SERIES POSITIVE-VOLTAGE REGULATORS

SLVS055F – APRIL 1981 – REVISED DECEMBER 1999

electrical characteristics, $V_I = 23\text{ V}$, $I_O = 500\text{ mA}$, $T_J = 25^\circ\text{C}$ (unless otherwise noted)

PARAMETER	TEST CONDITIONS†	TL780-15Y			UNIT
		MIN	TYP	MAX	
Output voltage	$I_O = 5\text{ mA to }1\text{ A}$, $P \leq 15\text{ W}$		15		V
Input voltage regulation	$V_I = 17.5\text{ V to }30\text{ V}$		1.5		mV
	$V_I = 20\text{ V to }26\text{ V}$		1.5		
Output voltage regulation	$I_O = 5\text{ mA to }1.5\text{ A}$		7		mV
	$I_O = 250\text{ mA to }750\text{ mA}$		2.5		
Output resistance	$f = 1\text{ kHz}$		0.0035		W
Output noise voltage	$f = 10\text{ Hz to }100\text{ kHz}$		225		μV
Dropout voltage	$I_O = 1\text{ A}$		2		V
Input bias current			5.5		mA
Short-circuit output current			230		mA
Peak output current			2.2		A

† Pulse-testing techniques maintain the junction temperature as close to the ambient temperature as possible. Thermal effects must be taken into account separately. All characteristics are measured with a 0.33- μF capacitor across the input and a 0.22- μF capacitor across the output.

PARAMETER MEASUREMENT INFORMATION

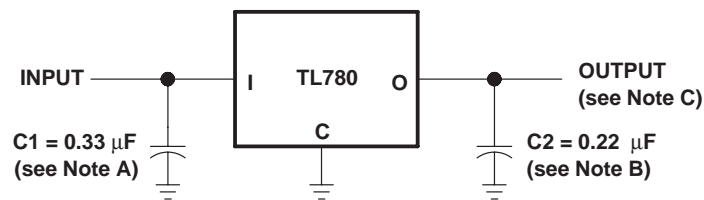

- NOTES: A. C1 is required when the regulator is far from the power-supply filter.
 B. C2 is not required for stability; however, transient response is improved.
 C. Permanent damage can occur when OUTPUT is pulled below ground.

Figure 1. Test Circuit

APPLICATION INFORMATION

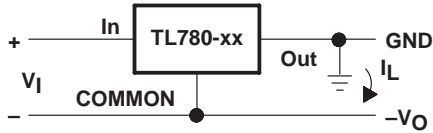

Figure 2. Positive Regulator in Negative Configuration (V_I Must Float)

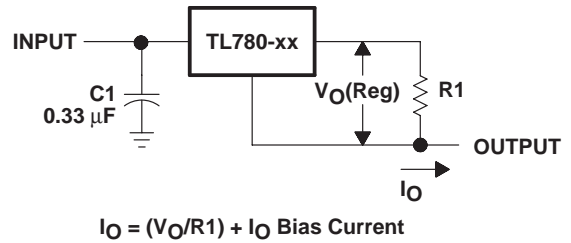

Figure 3. Current Regulator

operation with a load common to a voltage of opposite polarity

In many cases, a regulator powers a load that is not connected to ground but, instead, is connected to a voltage source of opposite polarity (e.g., operational amplifiers, level-shifting circuits, etc.). In these cases, a clamp diode should be connected to the regulator output as shown in Figure 4. This protects the regulator from output polarity reversals during startup and short-circuit operation.

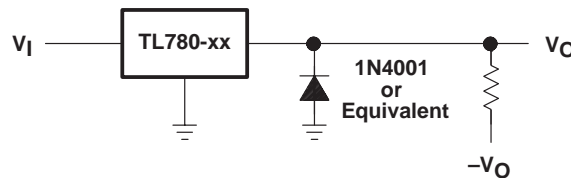

Figure 4. Output Polarity-Reversal-Protection Circuit

reverse-bias protection

Occasionally, the input voltage to the regulator can collapse faster than the output voltage. This, for example, could occur when the input supply is crowbarred during an output overvoltage condition. If the output voltage is greater than approximately 7 V, the emitter-base junction of the series pass element (internal or external) could break down and be damaged. To prevent this, a diode shunt can be employed, as shown in Figure 5.

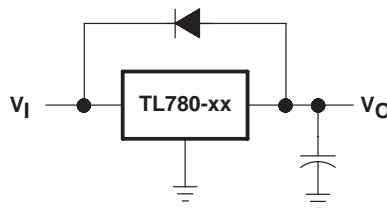

Figure 5. Reverse-Bias-Protection Circuit

IMPORTANT NOTICE

Texas Instruments and its subsidiaries (TI) reserve the right to make changes to their products or to discontinue any product or service without notice, and advise customers to obtain the latest version of relevant information to verify, before placing orders, that information being relied on is current and complete. All products are sold subject to the terms and conditions of sale supplied at the time of order acknowledgement, including those pertaining to warranty, patent infringement, and limitation of liability.

TI warrants performance of its semiconductor products to the specifications applicable at the time of sale in accordance with TI's standard warranty. Testing and other quality control techniques are utilized to the extent TI deems necessary to support this warranty. Specific testing of all parameters of each device is not necessarily performed, except those mandated by government requirements.

CERTAIN APPLICATIONS USING SEMICONDUCTOR PRODUCTS MAY INVOLVE POTENTIAL RISKS OF DEATH, PERSONAL INJURY, OR SEVERE PROPERTY OR ENVIRONMENTAL DAMAGE ("CRITICAL APPLICATIONS"). TI SEMICONDUCTOR PRODUCTS ARE NOT DESIGNED, AUTHORIZED, OR WARRANTED TO BE SUITABLE FOR USE IN LIFE-SUPPORT DEVICES OR SYSTEMS OR OTHER CRITICAL APPLICATIONS. INCLUSION OF TI PRODUCTS IN SUCH APPLICATIONS IS UNDERSTOOD TO BE FULLY AT THE CUSTOMER'S RISK.

In order to minimize risks associated with the customer's applications, adequate design and operating safeguards must be provided by the customer to minimize inherent or procedural hazards.

TI assumes no liability for applications assistance or customer product design. TI does not warrant or represent that any license, either express or implied, is granted under any patent right, copyright, mask work right, or other intellectual property right of TI covering or relating to any combination, machine, or process in which such semiconductor products or services might be or are used. TI's publication of information regarding any third party's products or services does not constitute TI's approval, warranty or endorsement thereof.