

Double Spherical Joint and Backlash Clutch for Lower Limbs of Humanoids

Masafumi OKADA^{*1}, Tetsuya SHINOHARA^{*1}, Tatsuya GOTOH^{*1},
Shigeki BAN^{*1} and Yoshihiko NAKAMURA^{*1,*2}

^{*1}Dept. of Mechano-Informatics, University of Tokyo
7-3-1 Hongo Bunkyo-ku Tokyo, 113-8656 Japan

^{*2}CREST Program, Japan Science and Technology Corporation

Abstract

In this paper, we develop two mechanisms for improving humanoid robot motions. The double spherical joint is a six DOF mechanism whose axes intersect in one point. This mechanism is for humanoid hip joints with a waist joint function without increasing an actuator. The backlash clutch realizes a high torque driving and a really free joint using backlash mechanism, and it is used for knee joints. The free mode will play a roll in humanoid behavior that is dynamically coupled with the environment. The humanoid robot with these two mechanisms is developed and results of preliminary experiments are to be shown.

Keywords: humanoid robots, biped walk, hip joint mechanism, knee joint mechanism

1 Introduction

Researches on humanoid robots extend to software architecture of control and intelligence. Development of mechatronics technology produce integration of sensors, actuators and motor drivers, which generates success mechanical design [1]~[6]. For the higher mobility of humanoid robots, the more degrees-of-freedom will be helpful. However, it requires further and harder challenge of integration, and it is not desirable from the lightweight and miniaturization points of view.

In this paper, we focus on the driving mechanism for humanoid robots. The specific problems raised in this paper are

- Joint allocation design that maximizes the whole body mobility of humanoid robots.
- Joint transmission design that switches between the drive and free modes.

The conventional humanoid robots walk with bending knee joints. It is for the high controllability of the center of gravity (COG) and the avoidance of singularity. However, it causes high energy consumption and requires

high power actuators in knee joints. The installation of the waist joints will get rid of this problem, and recent humanoid robots tend to have additional waist joint [6]. The importance of the waist joint is noticed for high mobility.

On the other hand, the current design of transmission of humanoid robots is not prepared to discuss dynamical coupling between the humanoid body and the environments. The natural human motion that we see in an elegant walk or in fine dancing is acquired through the coupling. Clearly, feeling the gravity and the environmental constraints not only with a specific sensor like vision but with the whole body dynamics suggests a design principle of sensory motor system of intelligent machines. Natural motions of humanoid robots may not be obtained from just imitating human motions. They would be acquired through the dynamics of their body and the environments including the gravitation. The passive walk of McGeer opened an interesting and suggestive approach to this problem[7, 8]

In this paper, we develop two mechanisms that improving the humanoid robot motion. The double spherical joint is six DOF mechanisms whose axes intersect in one point. By using this mechanism for humanoid hip joints, the waist joint function is realized without increasing an actuator. We also propose a joint drive mechanism that can switch between drive and free modes. The backlash clutch cuts mechanical transmission from the motor to the joint and the joint behaves like a free joint. In the drive mode, on the other hand, the backlash clutch engages the motor with the joint and transmits large forces. Conventional clutch mechanisms either weigh heavy or transmit insufficient forces. The backlash clutch solved the problem adopting a simple mechanism and a control algorithm. The backlash clutch is integrated in the knee mechanism of a humanoid robot.

The humanoid robot with the double spherical joint on the hip joint and the backlash clutch on the knee joints is developed. The preliminary results of experiments are to be shown in this paper to discuss the effectiveness of the body mobility.

2 Double spherical hip joint

Figure 1 shows the conventional hip joint mechanism. It

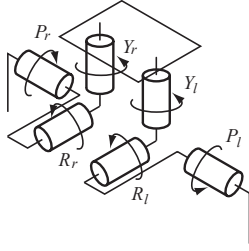

Figure 1: Conventional hip joints

has six degrees-of-freedom that is realized two spherical joints. Roll, pitch and yaw rotation are independent and kinematics of the lower limb is easy calculation. Figure 2 shows the motion of the upper body using conventional hip joint. Roll and yaw motions of upper body need bend-

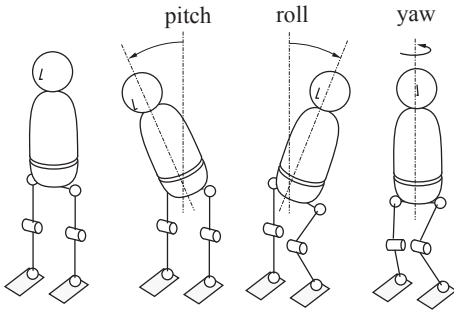

Figure 2: Motion of the upper body with conventional hip joint

ing knee joints for the purpose of avoiding singularity and large work space. The humanoid robot bends its knee joint while it is walking, which requires the high power actuator in knee joint. To set the waist joints avoids this singularity, however set of another joint increases the body weight.

On the other hand, Figure 3 shows the proposed double spherical hip joint. This mechanism has same number of degrees-of-freedom as conventional ones. $[]_r$ and $[]_l$ joints compose spherical joint respectively, and two centers of spherical joints coincide in one point.

Figure 4 shows the upper body motion of a humanoid robot with double spherical hip joint. Roll and yaw rotation can be realized without bending knee joint, which means that it is not necessary for humanoid robots to bend its knee joint in the walking motion. This mechanism does not realize only hip joint but also waist joints function. Figure 5 shows the design of the double spherical hip joint. Actuators are arranged so that the work

space becomes large. Figure 6 shows photographs of developed joint. 90[W] DC servomotors and 1:100 Harmonic drives gears are used to yaw and roll joints. In pitch joints, 150[W] DC servomotors and 1:100 Harmonic drives gears are used.

The workspaces of the designed joints are shown in Table 1. For the comparison, the motion ranges of human joints are shown. The workspace of this mechanism is as large as human.

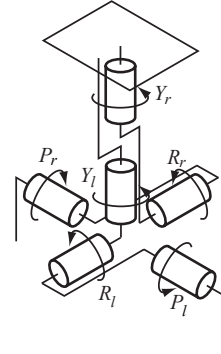

Figure 3: Double spherical hip joints

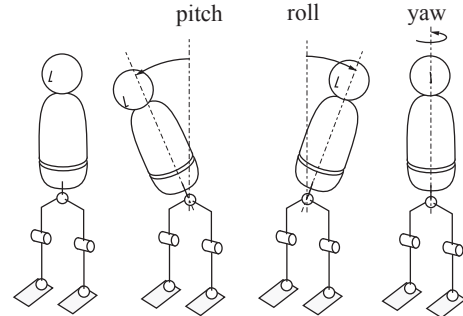

Figure 4: Motion of the upper body with double spherical hip joint

Table 1: Workspace of double spherical hip joints

	Double spherical joint	Human
Yaw	-35~35[degree]	-35~35[degree]
Roll	-50~50[degree]	-20~35[degree]
Pitch	-120~30[degree]	-135~90[degree]

3 Design of knee joint

3.1 Free motion in walking

Swing legs in walking motion take free swing motion after kicking the floor as shown in figure 7. The lower leg follows gravity and the knee joint does not generate

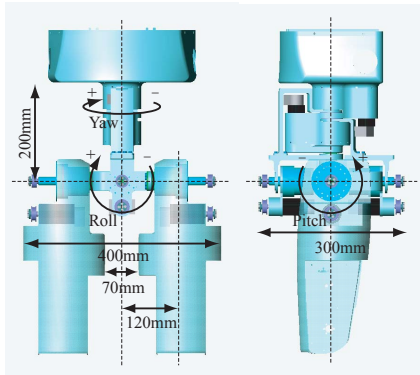

Figure 5: Design of double spherical hip joint

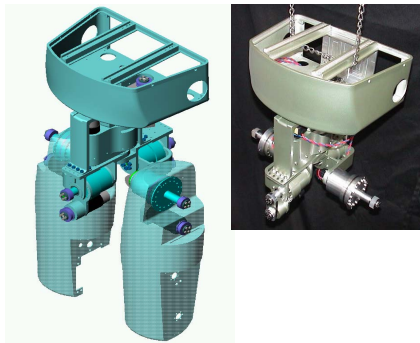

Figure 6: Photographs of double spherical hip joint

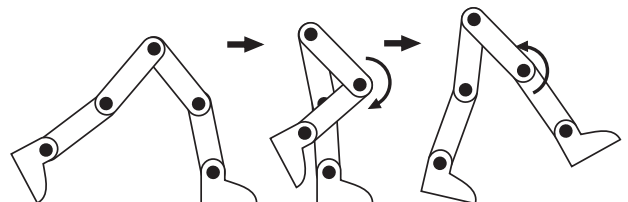

Figure 7: Free motion in walking

any torque. This motion is shown in passive walk[7, 8] that is human-like motion without energy consumption of actuator torque. It is necessary for humanoid robots to implement some mechanisms that realize the free motion for lightweight and small battery. Because the high torque transmission is necessary for knee joints, the normal clutch mechanism that has low transmission power using disk friction is not enough.

3.2 Design of backlash clutch

Figure 8 shows the designed backlash clutch. This mech-

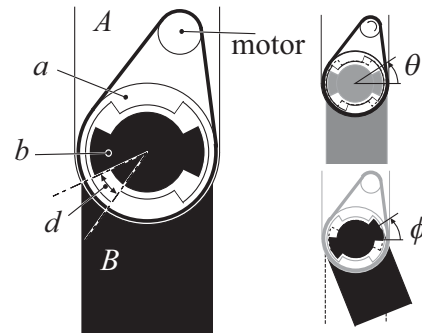

Figure 8: Backlash clutch

anism composes three components. Part *a* is on upper leg *A* and rotated by a motor. Part *b* is fixed to lower leg *B*. When the gap $d = 0$, the torque of motor is transmitted to *B* through *a* and *b*. By controlling the motor angle so that $d = \text{constant}$, free motion is realized and when $d = 0$, high torque transmission is realized in one rotational way. Generally, the external force of gravity works to the knee joint and one-way torque transmission is sufficient.

Figure 9 shows the components of backlash clutch. Each

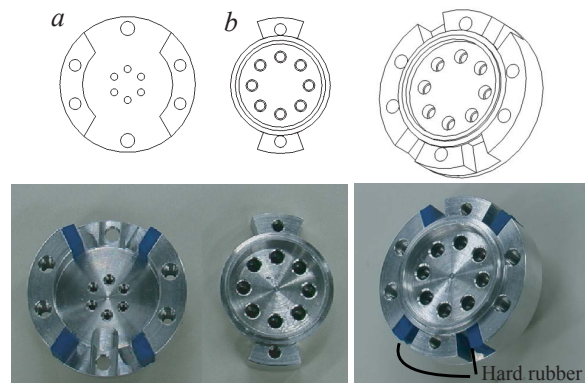

Figure 9: Components of backlash clutch

parts of *a* and *b* corresponds to that of figure 8. Hard rubber is implement as a shock absorber.

3.3 Design of knee joint

Figure 10 shows the designed knee joint using the backlash clutch. 150[W] DC servomotor and Harmonic drives

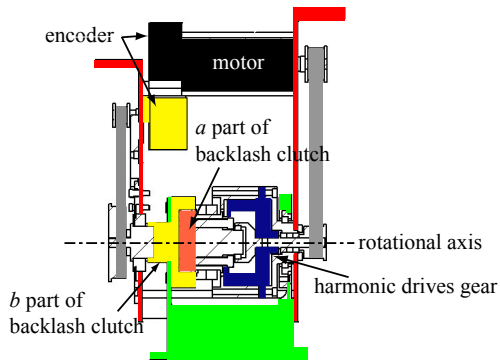

Figure 10: Design of knee joint

gear (gear ratio is 1:100) are used. The rotational angle θ in figure 8 is measured by an encoder attached to the motor and ϕ is measured by an additional encoder.

4 Design of humanoid robot

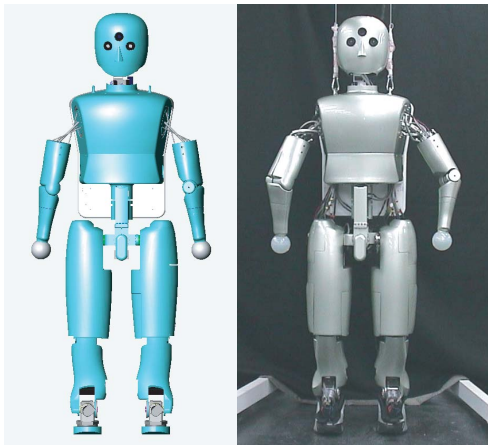

Figure 11: Whole body design of humanoid robot

We design the humanoid robot using the double spherical hip joint and the knee joint with backlash clutch. Figure 11 shows the whole body of the humanoid robot. It is as tall as 150[cm] and has about 50[kg] weight. The head mechanism is shown in figure 12. It has three degrees-of-freedom and two black and white progressive CCD cameras and one NTSC CCD color camera. The chest mechanism is shown in figure 13. The cybernetic shoulder[9] is used for large mobile area and human-like motion. It has three degrees-of-freedom and gyro sensors and acceleration sensors are in the body. The body

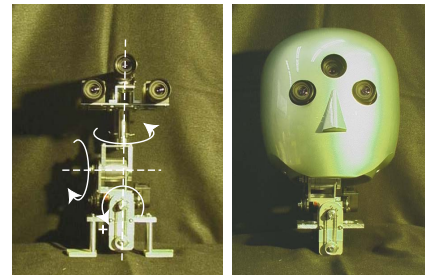

Figure 12: Head design

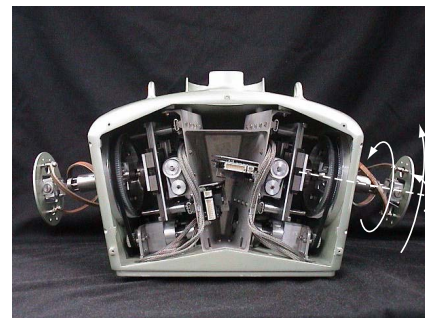

Figure 13: Chest mechanism

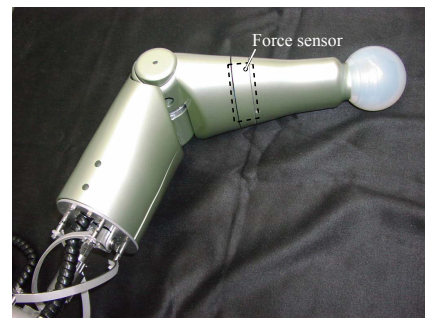

Figure 14: Elbow mechanism

is made of magnesium alloy casting for lightweight and high rigidness. Figure 14 shows the elbow mechanism. It has one degree-of-freedom and six axes force sensor.

Figure 15 shows the humanoid leg mechanism. There are one degree-of-freedom in knee and two degrees-of-freedom in ankles. The backlash clutch is implemented as figure

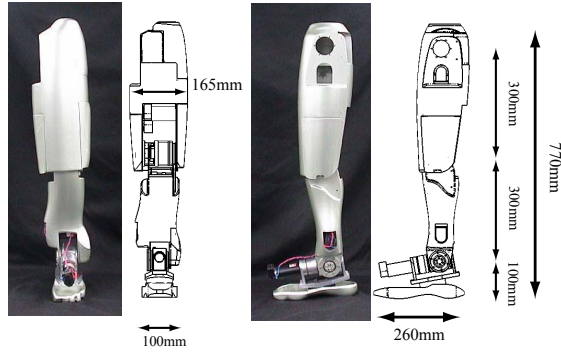

Figure 15: Design of humanoid leg

16.

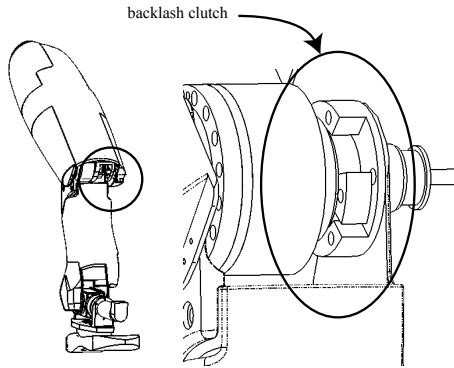

Figure 16: Location of backlash clutch

5 Control algorithm of knee joint

5.1 Two degrees-of-freedom control system

In this section, we propose a control algorithm of the backlash clutch. The backlash clutch needs the following three control modes.

Mode 1 Torque free

Mode 2 Torque transmission against external force (lock)

Mode 3 Transition from mode 1 to mode 2

To realize these three control modes, we adopt two degrees-of-freedom controller shown in figure 17. Here,

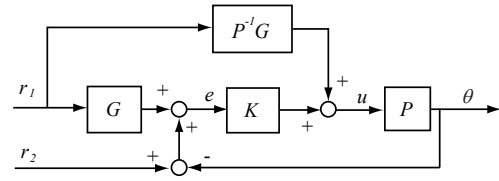

Figure 17: Two DOF control system

P means the transfer function of geared motor, K means the feedback controller, G means the transfer function that describes the desirable response of θ and r_1, r_2 are reference signals. G should be designed not to have zeros so that the response of θ does not have over shoot with the high gain feedback controller K .

r_1, r_2 are changed as follows according to the control mode.

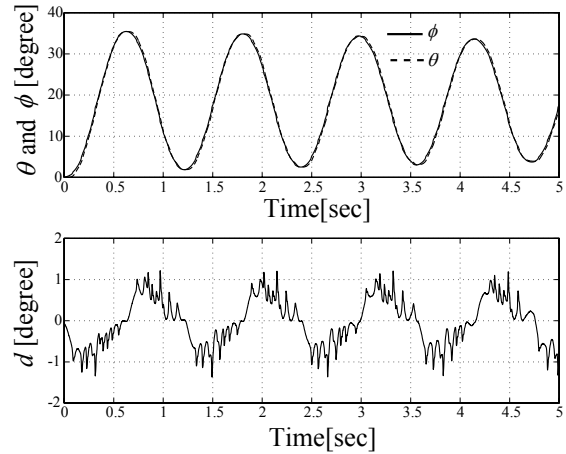

Figure 18: Experimental result of free motion

Case 1 r_1 and r_2 are set as

$$r_1 = 0, \quad r_2 = \phi \quad (1)$$

θ is controlled so that it follows ϕ and d is kept to be constant.

Case 2 r_1 and r_2 are set as

$$r_1 = \phi_{ref}(\text{reference angle of } \phi), \quad r_2 = 0 \quad (2)$$

so that this control system works as normal feedback controlled system at $t \rightarrow \infty$.

Case 3 r_1 and r_2 are set as

$$r_1 = \phi_{ref}, \quad r_2 = \phi \quad (3)$$

Because the two degrees-of-freedom control system is set so that the response of θ does not have over shoot, part a bumps part b calmly.

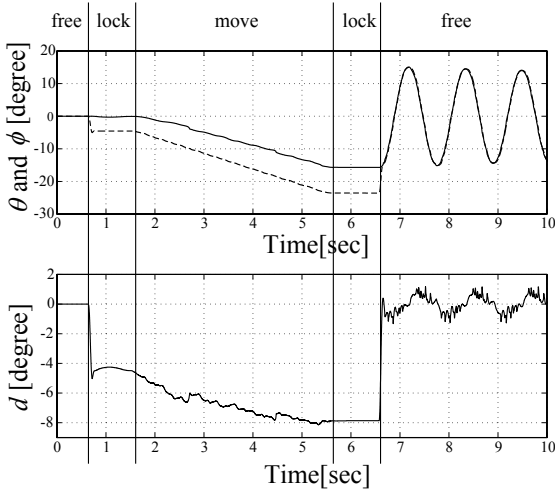

Figure 19: Experimental result for changing of control mode

5.2 Realization of free motion

By using the control law of mode 1, we realize the free motion of legs. Figure 18 shows the experimental results. The upper figure shows the responses of θ and ϕ in free swing of leg. The lower figure shows the gap $d(= \theta - \phi)$. Because opening of a and b is about 3[degree] and d is inside ± 2 [degree], free motion is realized.

Figure 19 shows the experimental result according to the change of control mode. The control mode is changed as follows.

- 0~0.8[sec] : mode 1
- 0.8~1.6[sec] : mode 3
- 1.6~5.6[sec] : mode 2 and bending the knee joint
- 5.6~6.6[sec] : mode 2
- 6.6~ : mode 1

The free motion, the high feedback control and the smooth transition of control mode are realized.

6 Conclusions

In this paper, we developed the double spherical joint and backlash clutch for lower limbs of humanoids. The results of this paper are as follows.

1. By the double spherical hip joint, the humanoid robot is not necessary to bend its knee joint to control the balance by the upper body.

2. The backlash clutch realizes both free motion and high torque transmission.

3. By using the two degrees-of-freedom control system, we realized the smooth transition of control mode.

4. By using two proposed mechanism for lower limbs, we developed the humanoid robot.

Acknowledgment

This research is supported by the "Robot Brain Project" under the Core Research for Evolutional Science and Technology (CREST program) of the Japan Science and Technology Corporation.

References

- [1] K. Hirai, M. Hirose, Y. Haikawa and T. Takenaka: The Development of Honda Humanoid Robot, Proc. of Int. Conference on Robotics and Automation, pp.1321-1326 (1998)
- [2] J Yamaguchi, E. Soga, S. Inoue and A. Takanishi: Development of a Bipedal Humanoid Robot - Control Method of Whole Body Cooperative Dynamic Biped Walking -, Proc. of Int. Conference on Robotics and Automation, pp.368-374 (1999)
- [3] A. Konno, N. Kato, S. Shibata, T. Furuta and M. Uchiyama: Development of a Light-Weight Biped Humanoid Robot, Proc. of Int. Conference on Intelligent Robots and Systems, pp.1565-1570 (2000)
- [4] K. Nishiwaki, T. Sugihara, S. Kagami, F. Kanehiro, M. Inaba and H. Inoue: Design and Development of Research Platform for Perception-Action Integration in Humanoid Robot:H6, Proc. of Int. Conference on Intelligent Robots and Systems, pp.1559-1564 (2000)
- [5] A. Konno, R. Sellaouti, F. B. Amar and F. B. Oueddou: Design and Development of the Biped Prototype ROBIA, Proc. of Int. Conference on Robotics and Automation, pp.1384-1389 (2002)
- [6] K. Kaneko, S. Kajita, F. Kanehiro, K. Yokoi, K. Fujiwara and H. Hirukawa, T. Kawasaki, M. Hirota and T. Isozumi: Design of Advanced Leg Module for Humanoid Robotics Project of METI, Proc. of Int. Conference on Robotics and Automation, pp.38-45 (2002)
- [7] T.McGeer: Passive Dynamic Walking, The International Journal of Robotics Research, pp.62-82 (1990)
- [8] T.McGeer: Passive Walking with Knees, Proc. of IEEE Robotics and Automation Conference, pp.1640-1645 (1990)
- [9] M.Okada, Y.Nakamura and S.Hoshino; Development of the Cybernetic Shoulder -A Three DOF Mechanism that Imitates Biological Shoulder-Motion -, Proc. of IEEE/RSJ International Conference on Intelligent Robots and Systems(IROS'99) pp.543-548 (1999)