

D

C

B

A

4

4

3

3

2

2

1

1

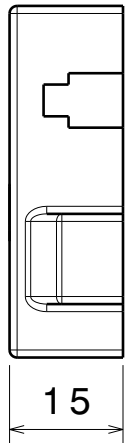
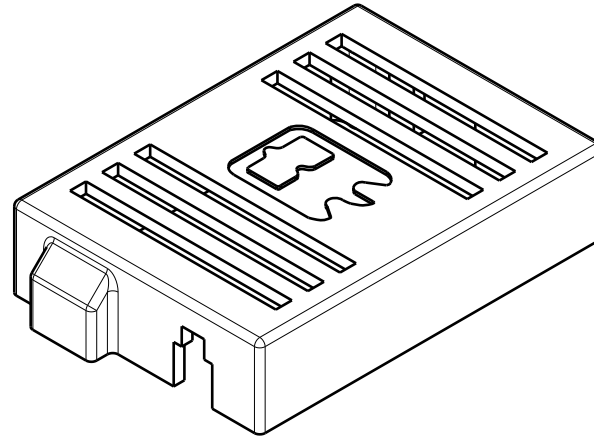
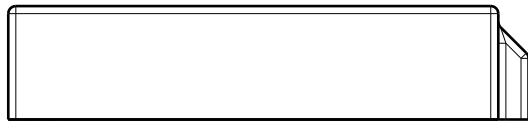

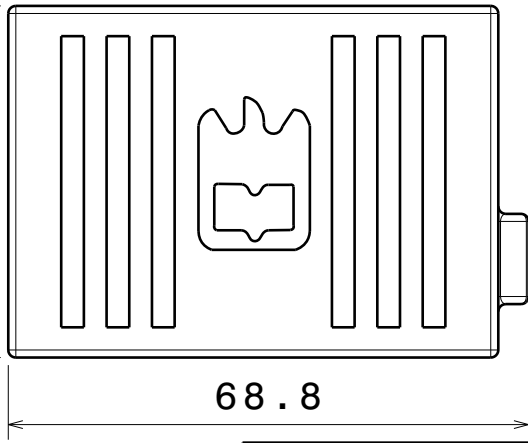

15

46.5

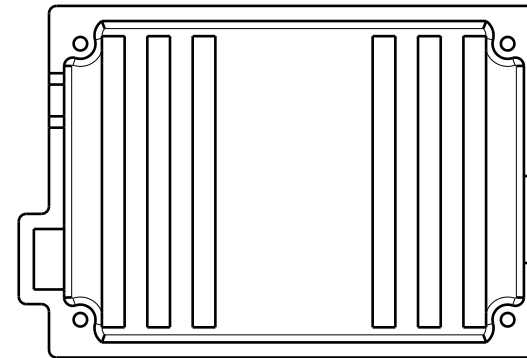
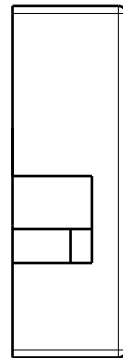

68.8



DESIGNED BY: JoãoFilipe		Name	Protection Case TOP	I	-
DATE: 20/03/2015		Material	PLA	H	-
CHECKED BY: XXX		Quantity	2	G	-
DATE: XXX		Thickness	2mm	F	-
SIZE A4		SequenceID	XXXX	E	-
SCALE 1:1	WEIGHT (kg) 0,00	GroupID	XXXX	D	-
This drawing is our property; it can't be reproduced or communicated without our written agreement.				C	-
				B	-
				A	-

D

A