

Slip Ring SM 070

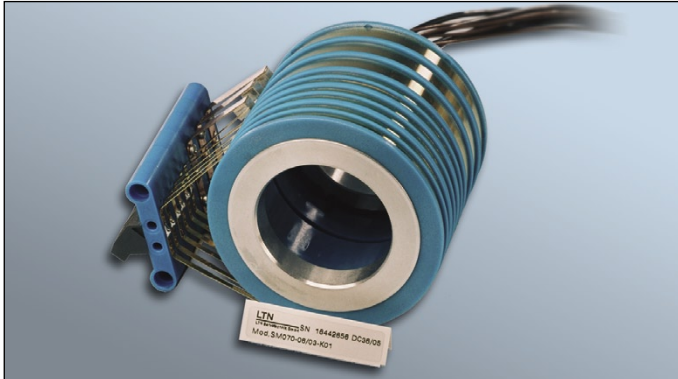

- Max. 24 rings with 3 A or max. 12 rings with 16 A
- Rings with 3 A or 16 A to be combined
- Outer diameter 70 mm
- Inner diameter max. 50 mm
- 240 V AC / 240 V DC
- Stator: clamp terminals, leads optional

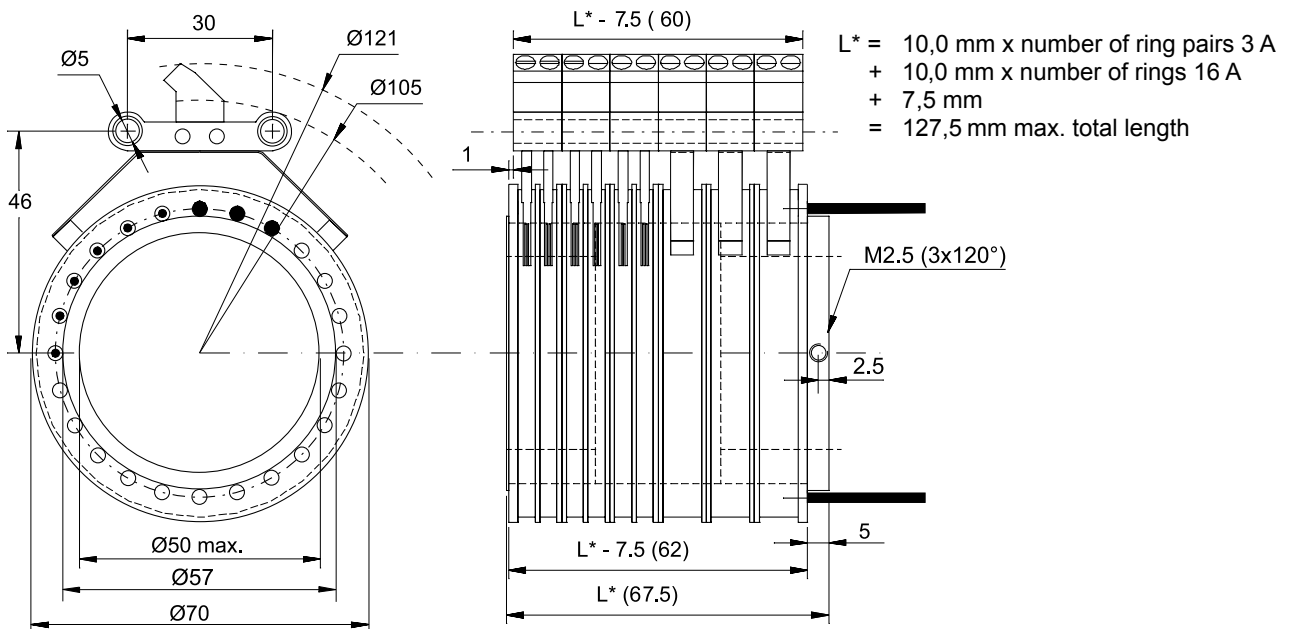

Electrical Data

Number of rings:	signal: max. 24 rings (pairwise); power: max. 12 rings, higher number of rings on request
Current:	signal: 3 A, max.; power: 16 A, max.
Voltage:	240 V DC / 240 V AC, higher voltage on request
High pot:	500 V AC
Insulation resistance:	1000 MΩ at 500 V DC
Noise:	60 mΩ at 5 1/min and 6 V DC, 50 mA for gold / gold contacts
Contacts:	Gold / gold or silver carbon / brass

Mechanical Data

Speed:	max. 250 rpm, higher on request
Protection class:	IP 00
Temperature:	-20 °C ... +80 °C (-5 °F ... +175 °F)
Rotor connection:	300 mm leads; others on request
Stator connection:	Clamp terminals; leads optional

LTN Servotechnik GmbH

Order Information

Type of slip ring:		<table border="1"><tr><td>S</td><td>M</td><td>0</td><td>7</td><td>0</td></tr></table>	S	M	0	7	0				
S	M	0	7	0							
No. of rings with:	max. 3 A max. 16 A	<table border="1"><tr><td></td><td></td></tr><tr><td></td><td></td></tr></table>					Standard: 24 max. Standard: 12 max.				
Length of leads in mm:	Rotor Stator	<table border="1"><tr><td></td><td></td><td></td><td></td></tr><tr><td></td><td></td><td></td><td></td></tr></table>									Standard: 300 mm Standard: clamp terminals
Inner diameter in mm:		<table border="1"><tr><td></td><td></td></tr></table>			Standard: 50 mm, max.						

LTN Servotechnik GmbH

Georg-Hardt-Straße 4
D-83624 Otterfing
Germany

Tel: +49 - (0)8024-6080-0

Fax: +49 - (0)8024-6080-100

E-Mail: LTN@LTN.de

Internet: www.LTN.de