



## Create a MaxStream Zigbee 5v Interface Using a SParkFun MaxStream Breakout board. Type 3

Most Zigbee modules are powered by a 3.3v power source. This also means the IO leads can not exceed this voltage. In order to use them with our 5v circuits we need to create an interface. The Maxstream modules also present a problem because they utilize a 2mm pinout so they cant be used with most prototype boards. To solve this problem we will use SparkFun breakout board to convert the MaxStream to .1" headers so that it can be plugged into any prototype board. You may even use the SparkFun breakout board with standered breadboards as well. Once finished the board you create in this article will allow you to power the module with 5v and access the transmit and receive leads using just about any 5v microcontroller.

### By the Numbers

I will take you through the process of adding the componets to the proto board step by step. You will need the following:

- 1, .1" Proto Board
- 5, male header pins
- 2, 10-pin .1" female sockets
- 1, 3.3K Resistor
- 1, 1.8K Resistor
- 1, 100 Ohm Resistor
- 1, 10K Resistor
- 1, 470 Ohm Resistor
- 1, 3.3v 100ma regulator
- 1, Green LED.
- SparkFun MaxStream Breakout Board
- 2, 10-pin 2mm headers.

I will present a complete source for all the componets at the end of this article.

### Step 1

First you need to assemble the breakout board as shown here. This involves attaching the two 2mm headers and the two .1" headers.

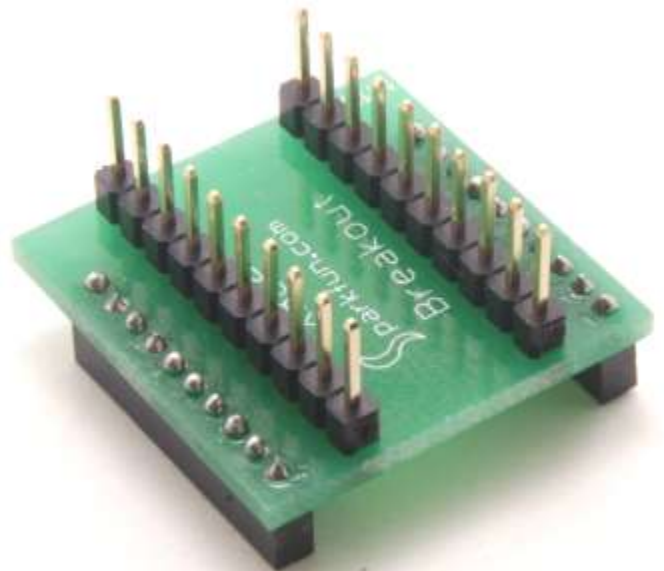

## Step 2

Next you need to install two 10-pin female headers on the main prototyping board as shown here. You can purchase 10-pin headers or cut them off of a larger header.

It's important that you get the .1" sockets installed properly so that the rest of the instructions match.

Pin 1 of the first is located 10 over and 4 down as shown. Pin 1 of the second socket is located 5 over from the right edge and 4 down as shown.

\* The first header is only 4 down due to the fact that one of the holes on the top of the board does not exist.

You can plug an Xbee module into the sockets to make soldering easier.

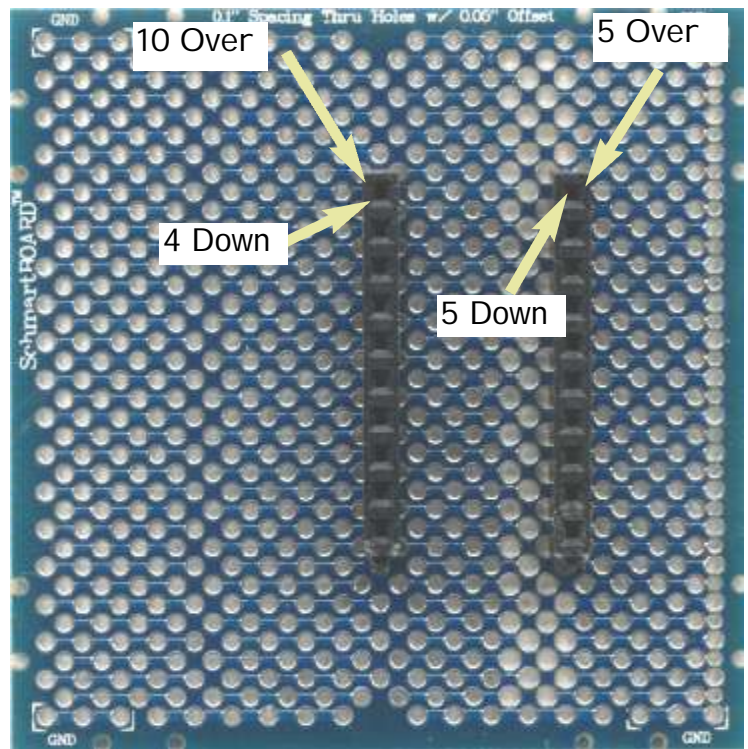

## Step 3

Attach the 3.3v regulator as shown. The Inset shows the actual holes used for the regulator pins.

Pin 3 on the regulator is connected to Pin 1 on the first header. Note that this is the output of the regulator and the 3.3v Vcc input to the Xbee module.

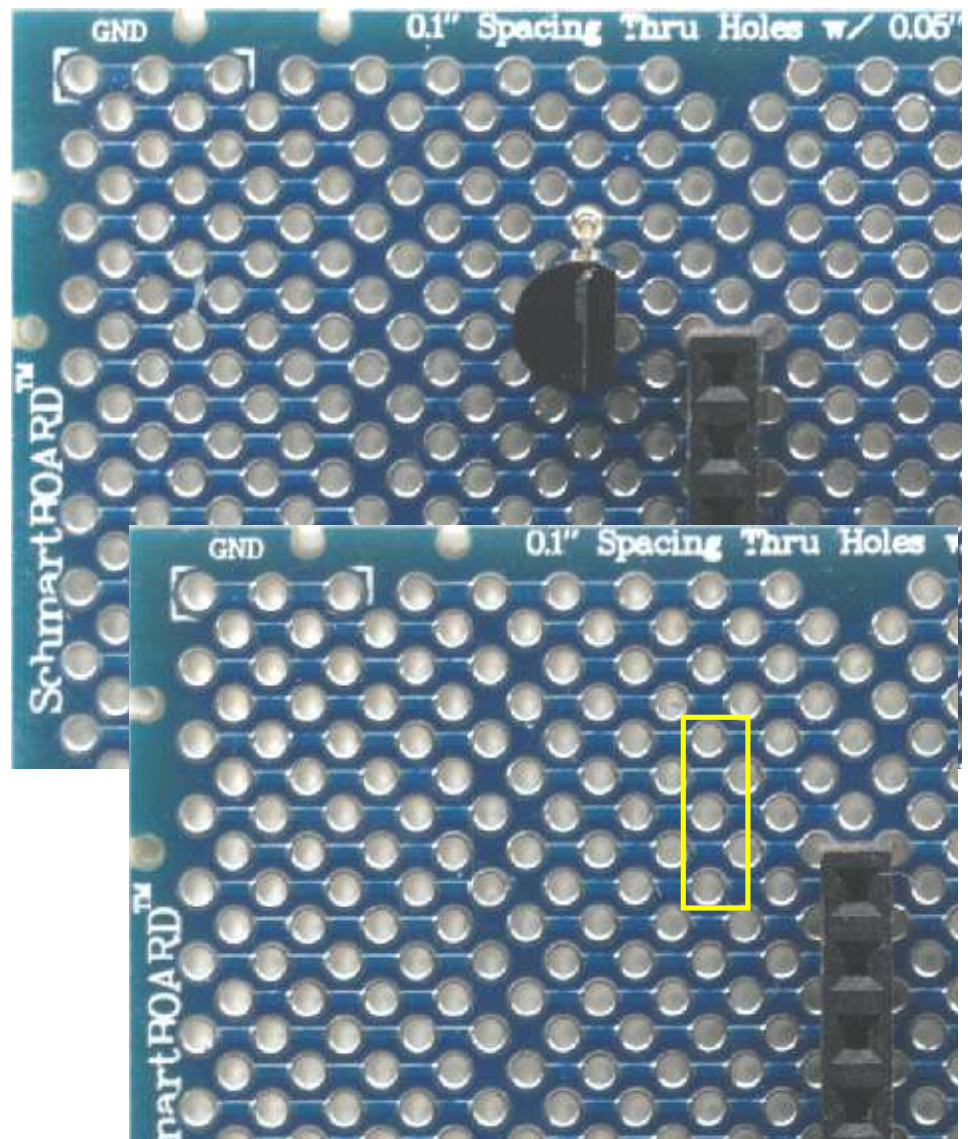



#### Step 4

You will need to break off 5 header pins and solder them into the pins shown.

Notice that I have used a second board to show the actual holes.

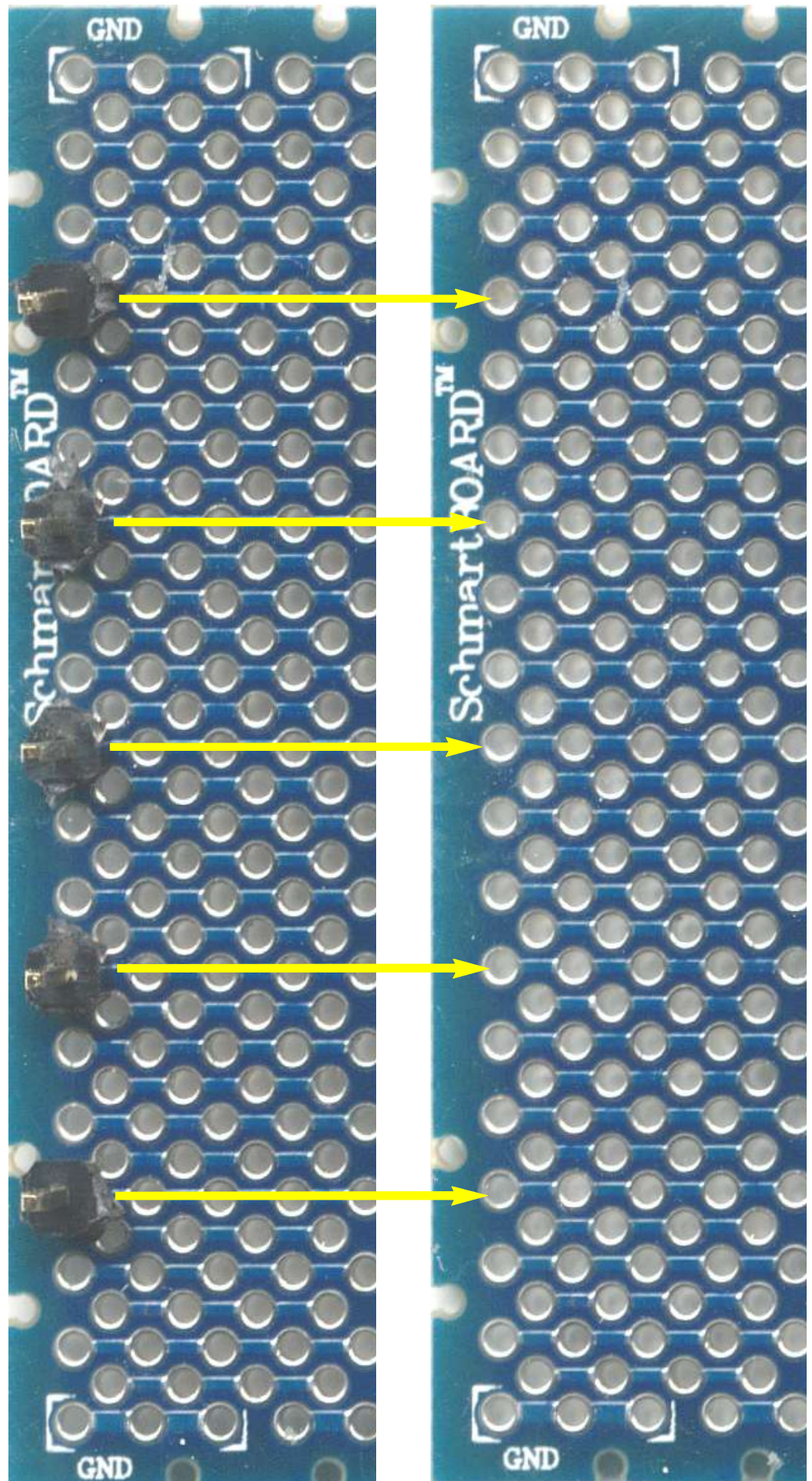



### Step 5

Connect a 100 ohm resistor (Brown, Black Brown) as shown. The resistor connects between pin 2 on the female header and the First male header pin (TX to Microcontroller)

### Step 6

Connect a 1.8K resistor (Brown, Grey Red) as shown. The resistor connects between pin 3 on the female header and the second male header pin (RX from microcontroller)

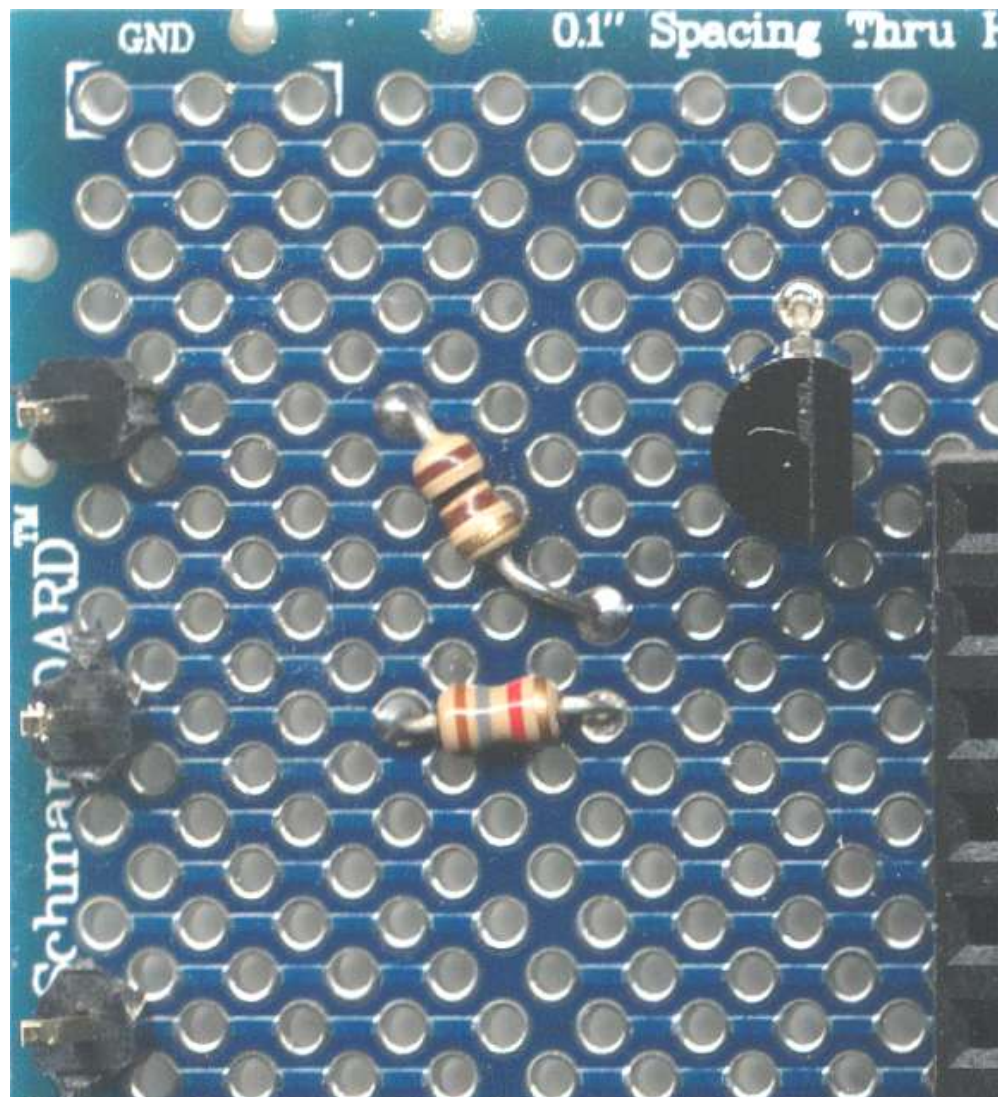

### Step 7

Connect a 3.3K resistor (Orange, Orange, Red) as shown. The resistor connects between pin 3 on the female header and the center pin on the regulator.

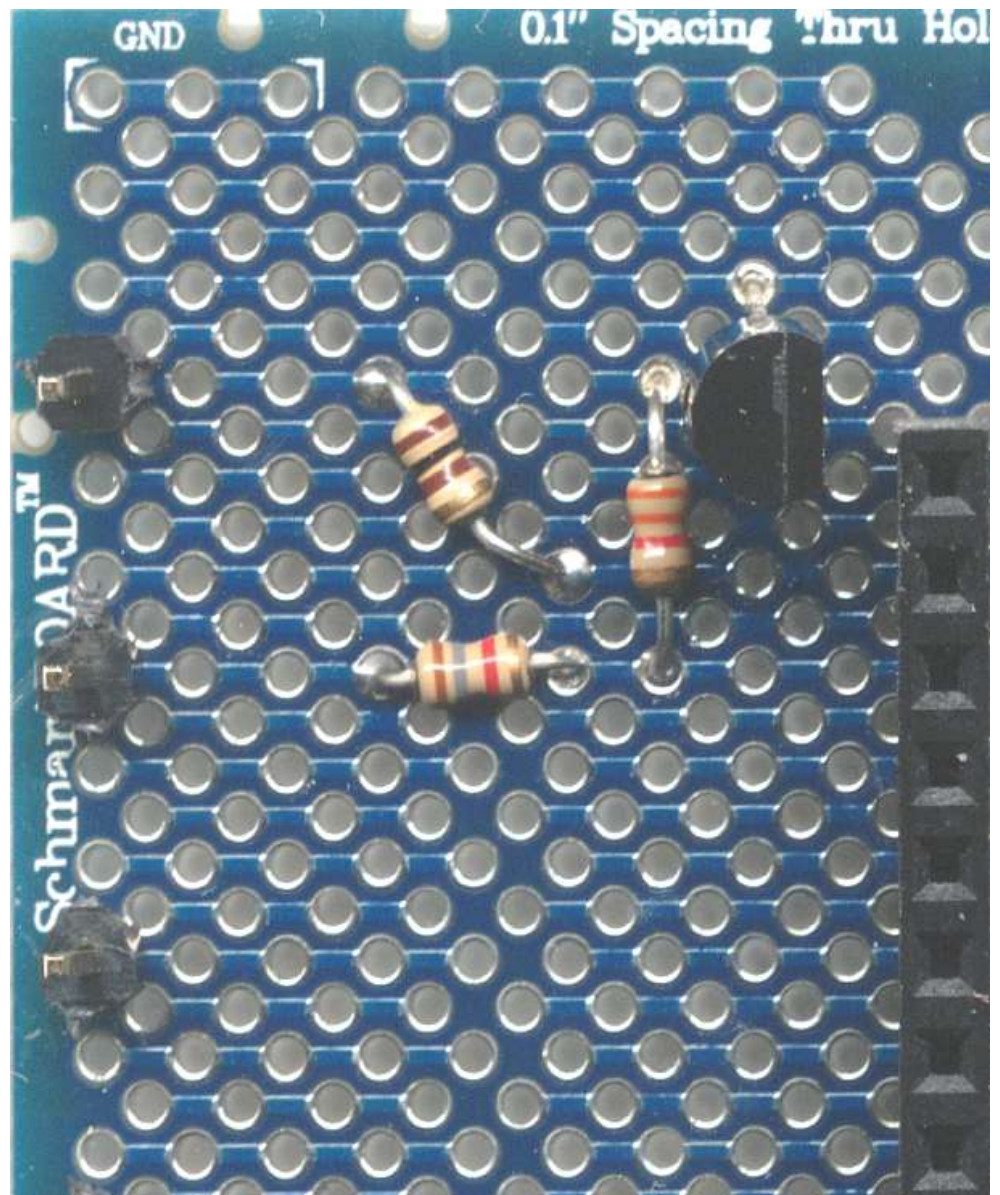



### Step 8

Connect a 10K resistor (Brown, Black, Orange) as shown. The resistor connects between pin 5 on the female header and the third male header(Reset)





### Step 9

Connect an LED as shown. The inset shows the actual holes used. The short lead is connected to pin 10 on the female header.

### Step 10

Connect a 470 Ohm resistor (Yellow, Violet, Brown) as shown. The resistor is connected between pin 6 on the female header and the long lead of the LED.

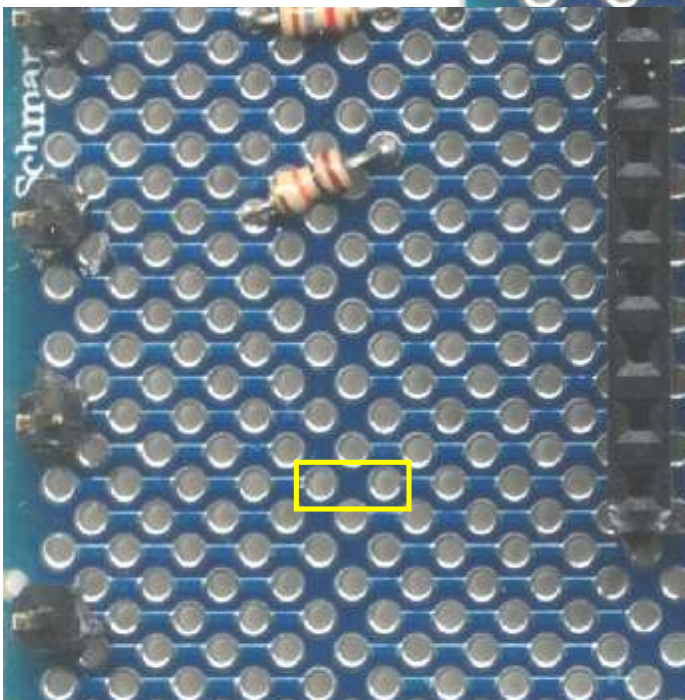
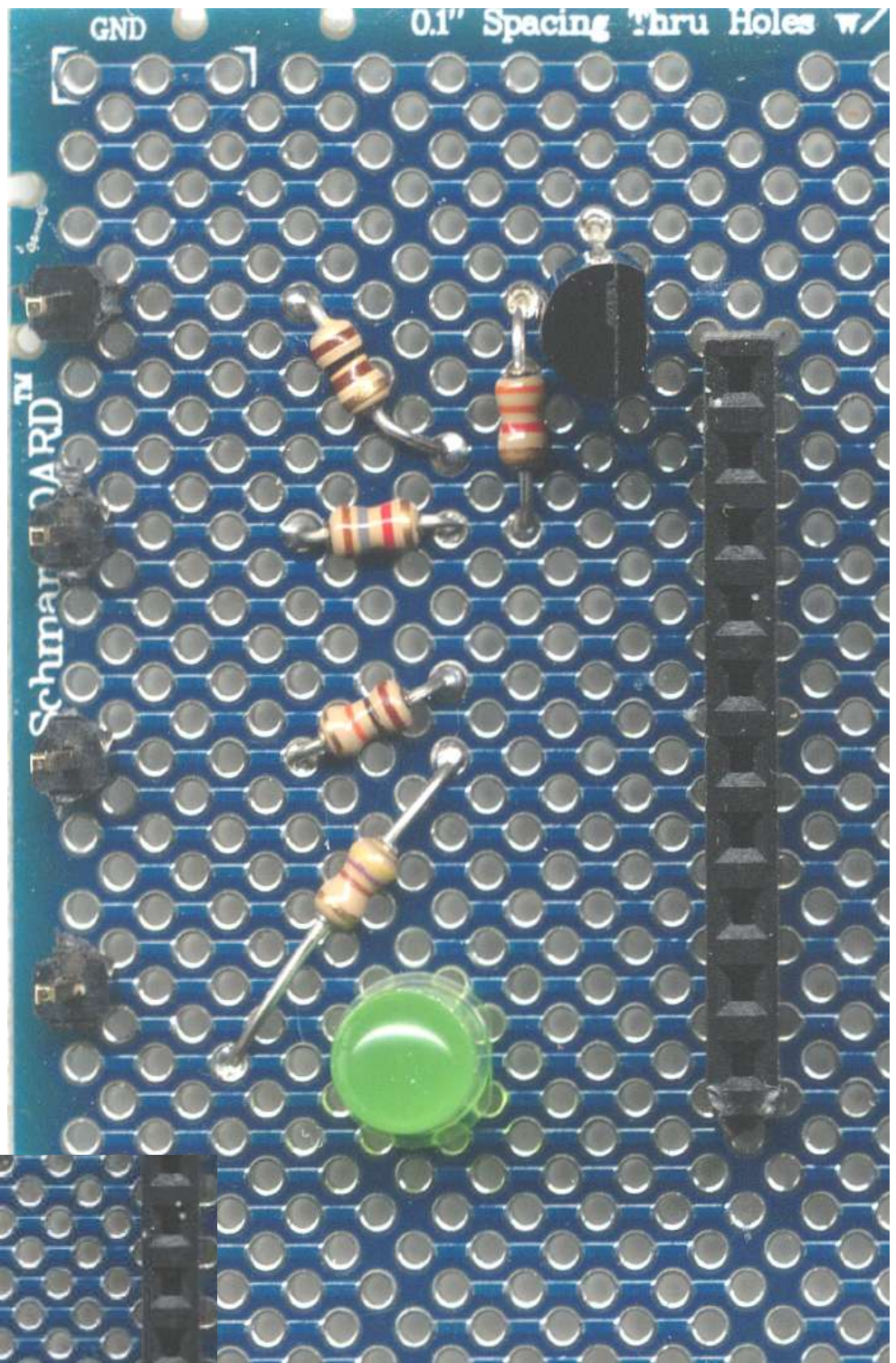



### Step 11

Connect a jumper (Orange) between the center lead on the regulator (Gnd) and the 5th male header (Vss, Gnd).

### Step 12

Connect a jumper (Yellow) between pin 10 on the female header and the 5th male header (Vss, Gnd)

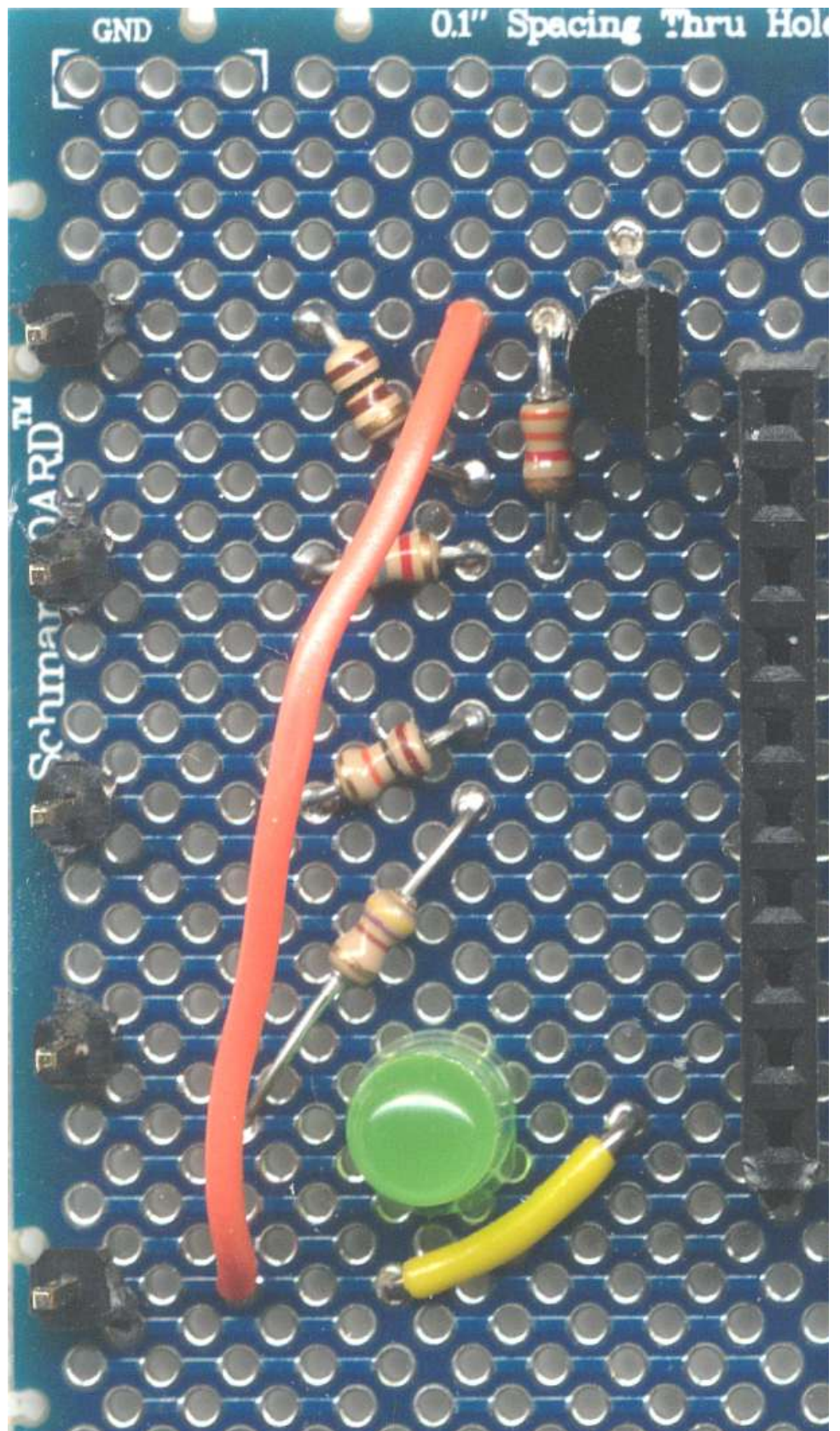



### Step 13

Connect a jumper (Yellow) between pin 3 (Vin) on the regulator and the 4th male header. (5v In)

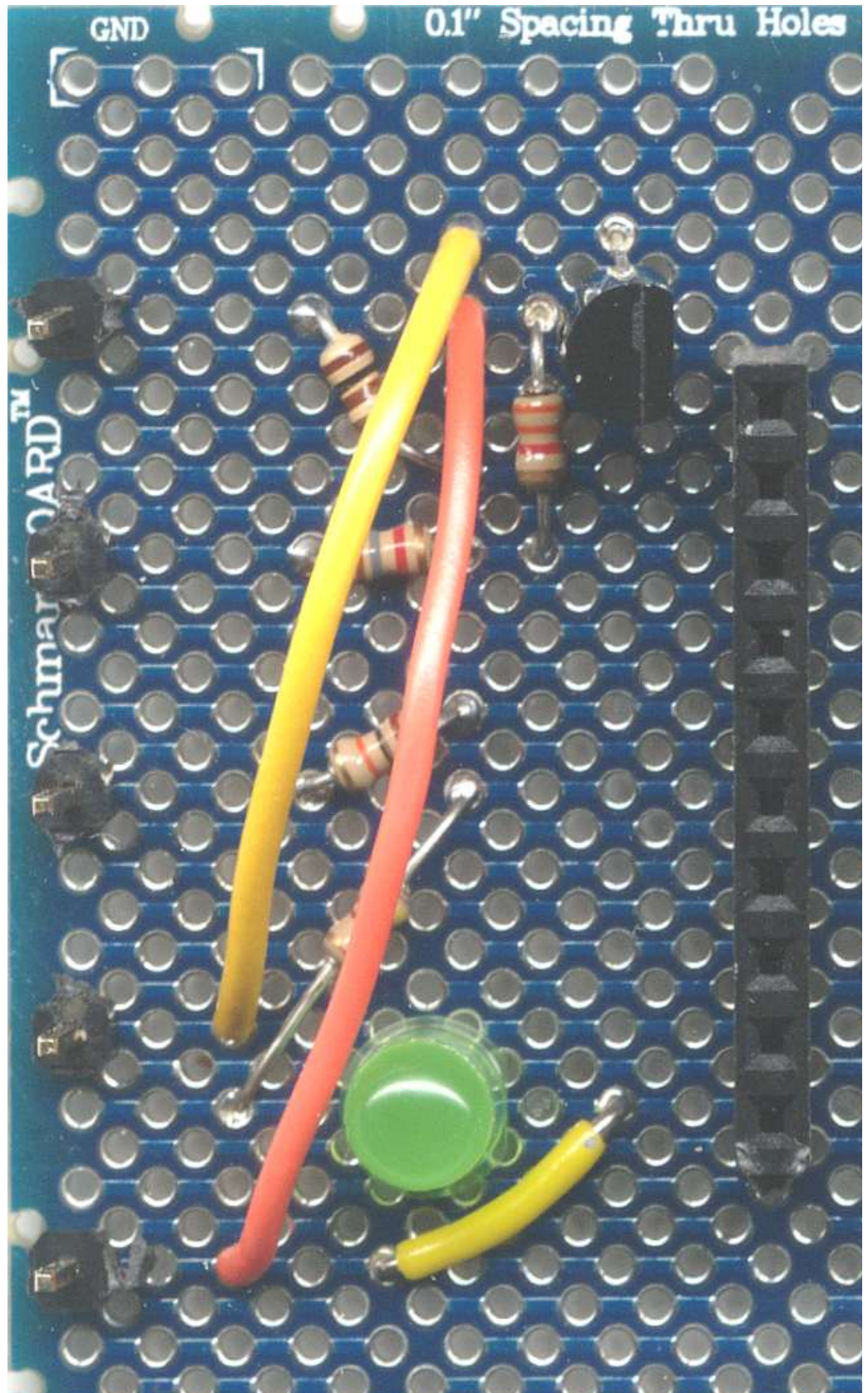



## Step 14

Before you plug the Xbee module into the sockets you need to test the voltage.

Connect 5v to the Vdd and Vss header pins and take a reading on the socket pins 1 and 10.

It should read 3.2v to 3.3v.

Measure Here. Should be 3.2 to 3.3 volts.

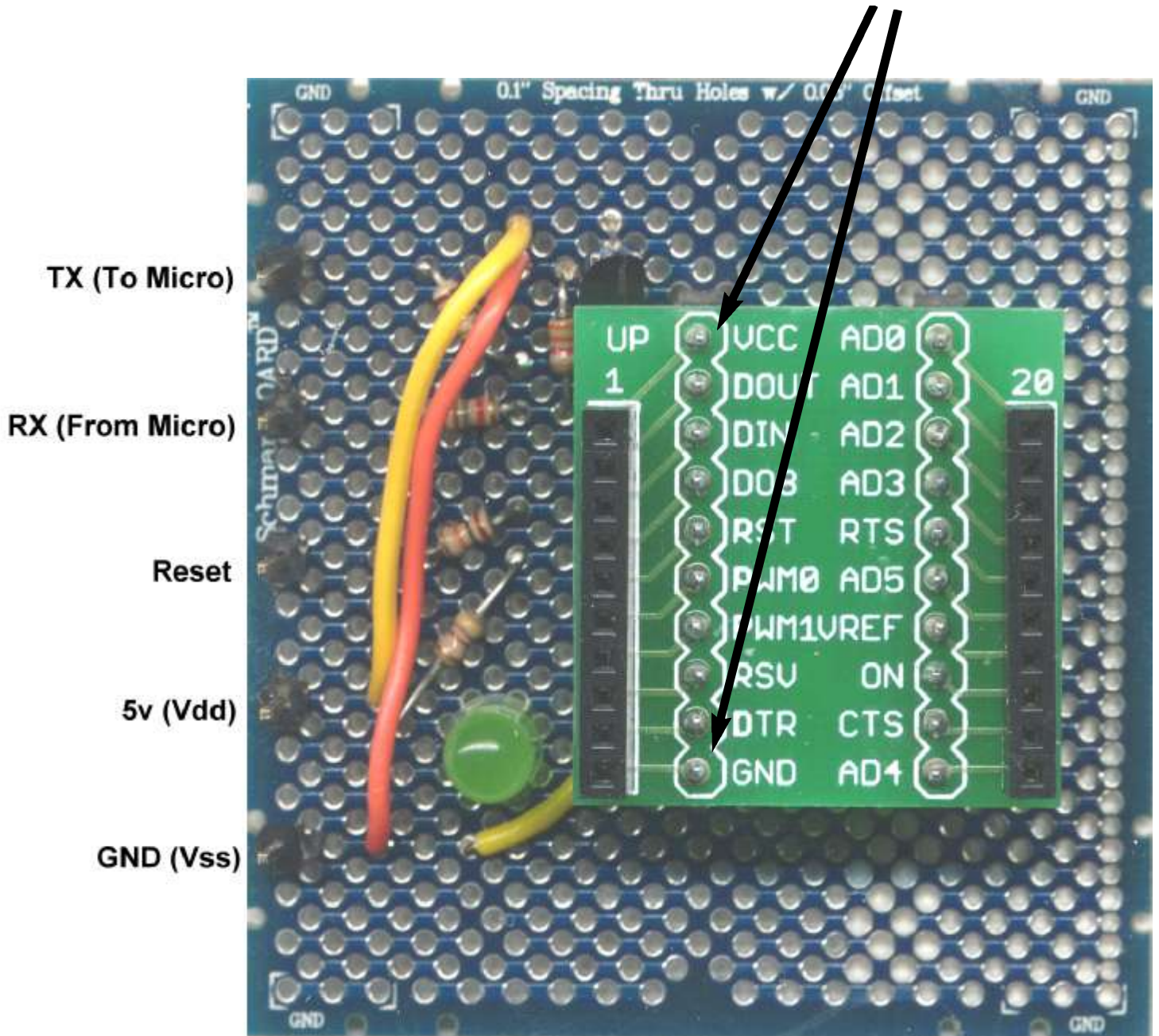



Once the voltage has been verified you can plug the Xbee module into breakout board then plug the breakout board into the the female headers as shown below. When the module recives data from another module the LED will light. The brighter the LED the stronger the signal.

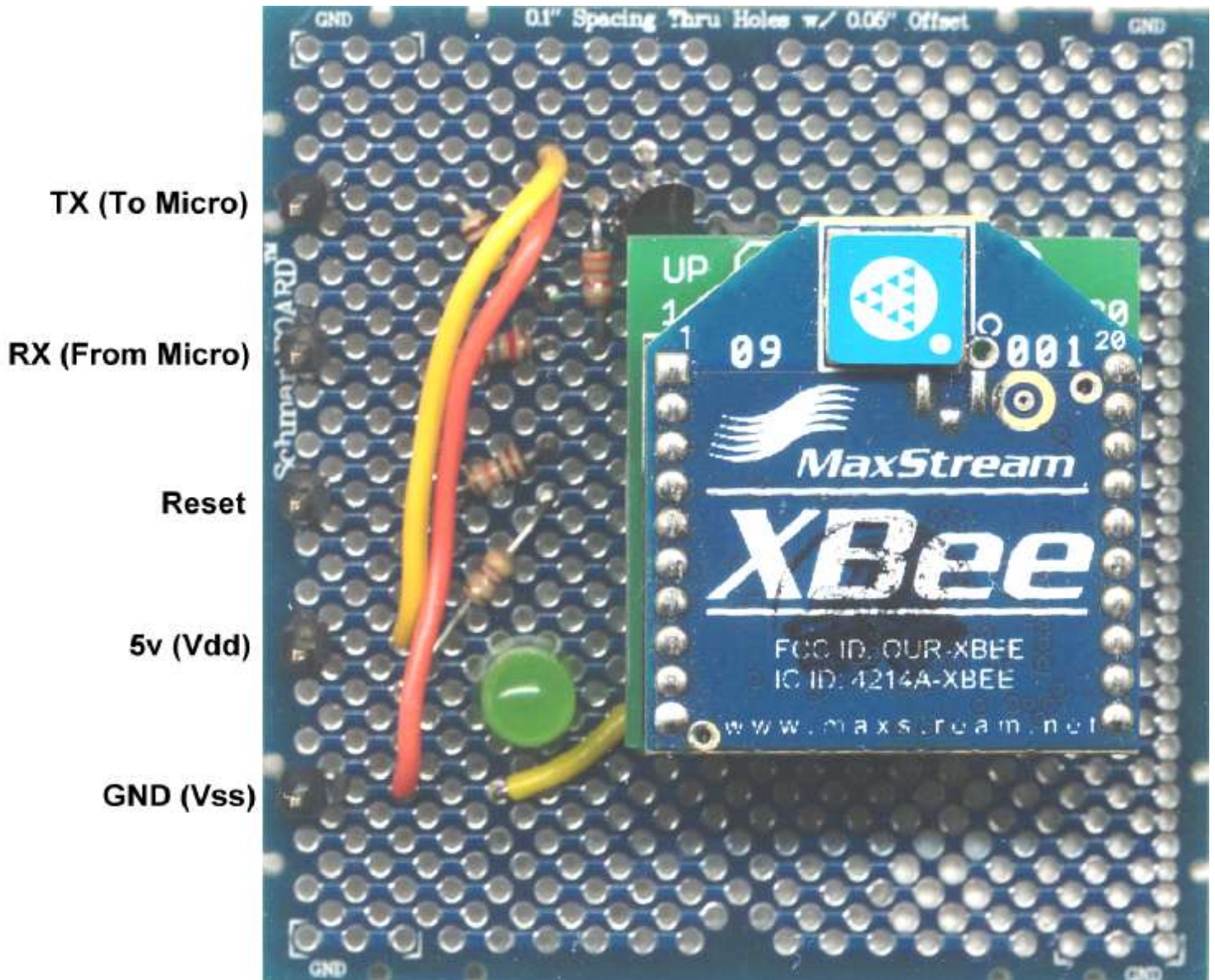

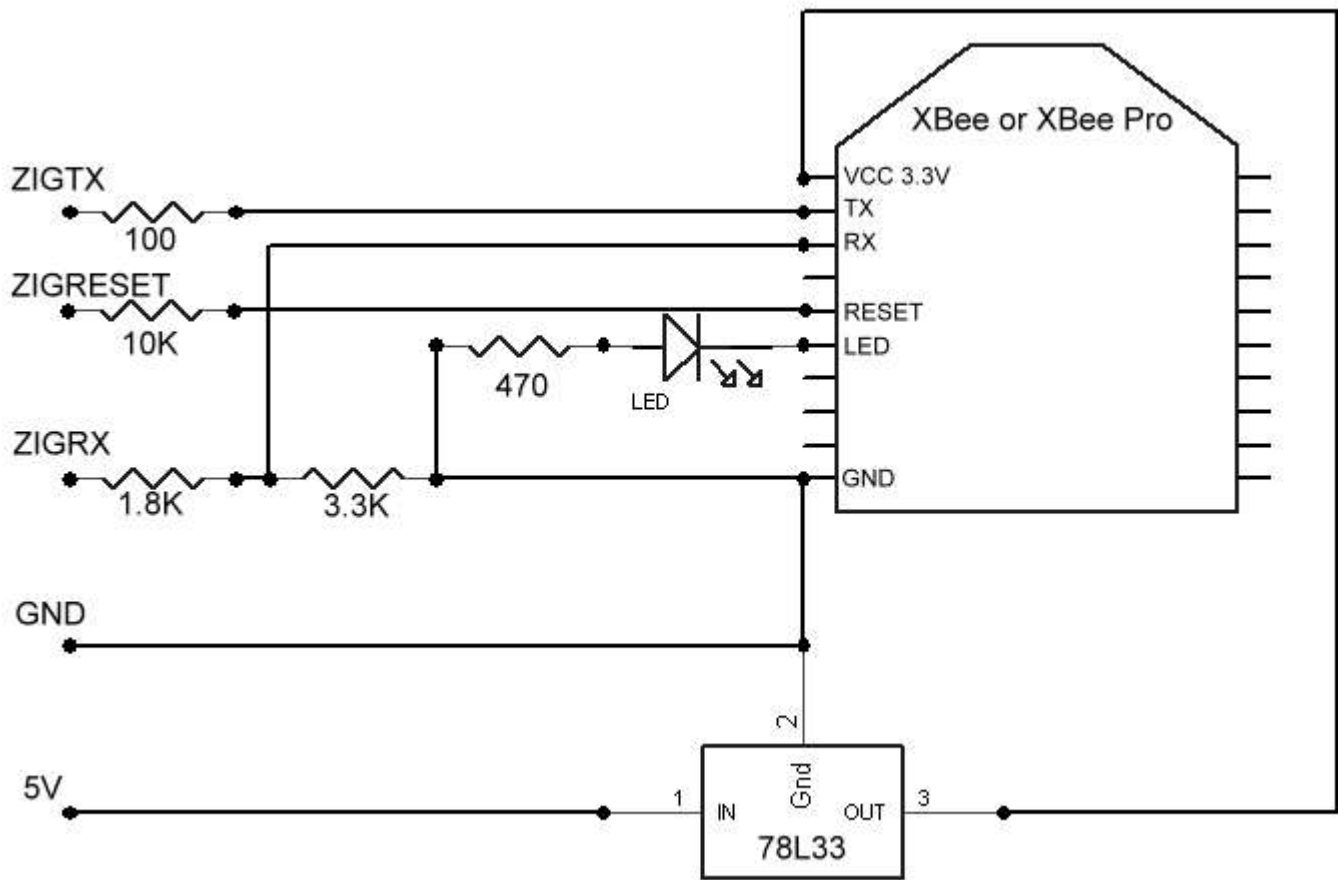

Schematic



# Parts

## MaxStream

XBee

[www.maxstream.net/products/xbee/xbee-oem-rf-module-zigbee.php](http://www.maxstream.net/products/xbee/xbee-oem-rf-module-zigbee.php)

XBee Pro

[www.maxstream.net/products/xbee/xbee-pro-oem-rf-module-zigbee.php](http://www.maxstream.net/products/xbee/xbee-pro-oem-rf-module-zigbee.php)

## SmartBoard

[http://www.schmartboard.com/index.asp?a=11&page=a\\_products\\_th&id=24](http://www.schmartboard.com/index.asp?a=11&page=a_products_th&id=24)

## Kronos Robotics

<http://www.kronosrobotics.com>

### 3.3v regulator

<http://www.kronosrobotics.com/xcart/customer/product.php?productid=16452>

### 1.8K Resistors

<http://www.kronosrobotics.com/xcart/customer/product.php?productid=16529>

### 3.3K Resistors

<http://www.kronosrobotics.com/xcart/customer/product.php?productid=16530>

### 100 Ohm Resistor

<http://www.kronosrobotics.com/xcart/customer/product.php?productid=16175>

### 10K Resistor

<http://www.kronosrobotics.com/xcart/customer/product.php?productid=16181>

### 470 Ohm Resistor

<http://www.kronosrobotics.com/xcart/customer/product.php?productid=16177>

### LED

<http://www.kronosrobotics.com/xcart/customer/product.php?productid=16235>

## SparkFun

### Xbee Module Breakout Board

[http://www.sparkfun.com/commerce/product\\_info.php?products\\_id=8276](http://www.sparkfun.com/commerce/product_info.php?products_id=8276)

### 2mm Sockets

[http://www.sparkfun.com/commerce/product\\_info.php?products\\_id=8272](http://www.sparkfun.com/commerce/product_info.php?products_id=8272)

### Male Headers

[http://www.sparkfun.com/commerce/product\\_info.php?products\\_id=116](http://www.sparkfun.com/commerce/product_info.php?products_id=116)

### Female headers (Not Breakaway, but can be cut)

[http://www.sparkfun.com/commerce/product\\_info.php?products\\_id=115](http://www.sparkfun.com/commerce/product_info.php?products_id=115)